

SMEVA Vision MKII

Schematic topview Corners 90° 'Kube' (KU)

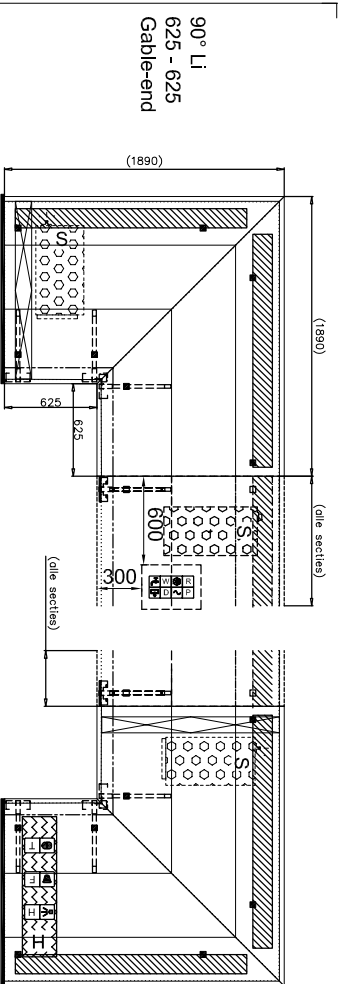

90° Li
625 - 625
Gable-end

90° Re
625 - 625
Section-cut

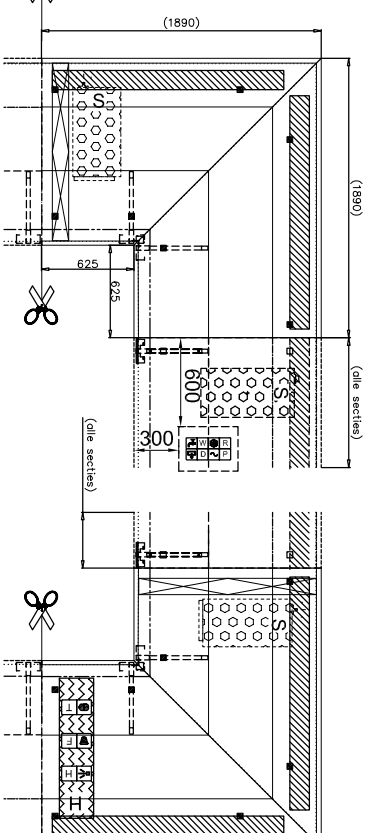

90° Re
625 - 625
Section-cut

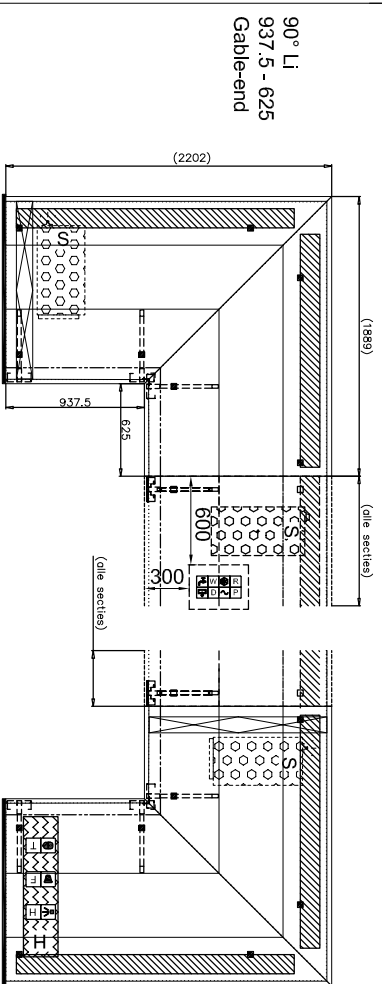

90° Li
937.5 - 625
Gable-end

90° Re
625 - 937.5
Gable-end

90° Li
937.5 - 625
Section-cut

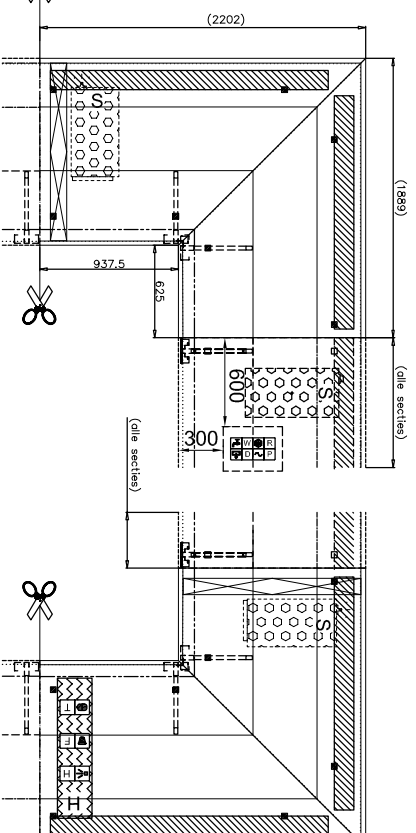

90° Re
625 - 937.5
Section-cut

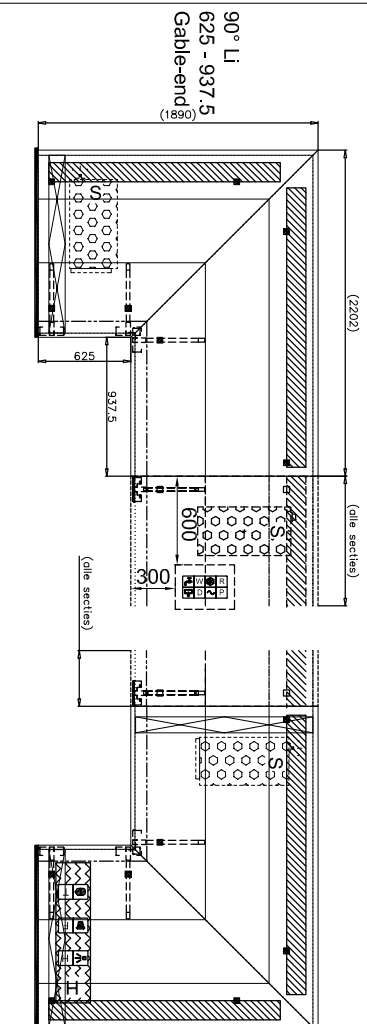

90° Li
625 - 937.5
Gable-end

90° Re
937.5 - 625
Gable-end

90° Li
625 - 937.5
Section-cut

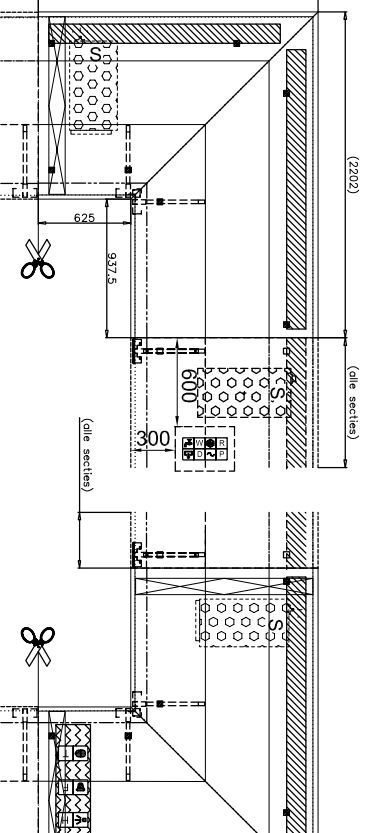

90° Re
937.5 - 625
Section-cut

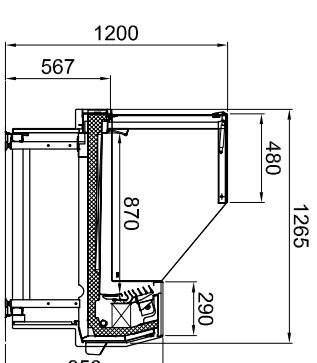

Vision MKII "Assisted"
(scale 1:20)

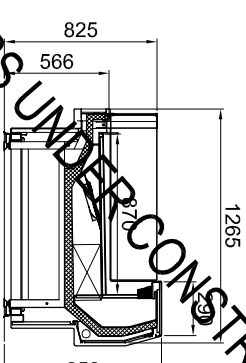

CORNERS UNDER CONSTRUCTION
VISION MKII "Self service" Pre-packed"
(scale 1:20)

- Floorconnections
 - Solenoidvalve-section
 - Electric cabinet
 - Electric cabinet (connection box)
 - Gable-end
 - Leg position
 - Defrost unit
 - Coil
 - Humidifier-unit (filter)
 - Humidifier-unit (no filter)
 - Nightcover storage (Optional)
- R = Refrigeration
 P = Power supply
 W = Water supply
 D = Drain / Sewerage

consumer side

consumer side

Customer:	Creation date:	10-03-2016
Department: R & D	Projector:	
Project: VISION MKII	Drawn by: PL	Scale: 1:25
P R O D U C T S		
Title: VISION MKII FLOORPLAN Corners 90° 'Kube' (KU)		
Size: A1	Rev.: 00	